



Spezialprofile  
Special Profiles

Bühnen- und Zeltbau	Stage Construction / Tent Construction	39
Fahrzeugbau	Vehicle Construction	43
Fassadenbau	Facade Construction / Building	44
Glasbau	Glass Construction / Building	46
Metallbau	Metal Construction	48
Solar und Photovoltaik	Solar / Photovoltaic Profiles	55
Sonnen- und Insektenschutz	Sun and Insect Protection	56
Terrassenbau	Terrace Construction / Building	59
Tischlerei und Möbelbau	Carpentry / Furniture Construction	60
Volierenbau	Aviary Construction	61
Sonstige	Other	62



Bühnen- und Zeltbau  
Stage Construction /  
Tent Construction

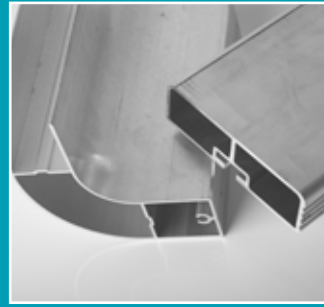

Fahrzeugbau  
Vehicle Construction

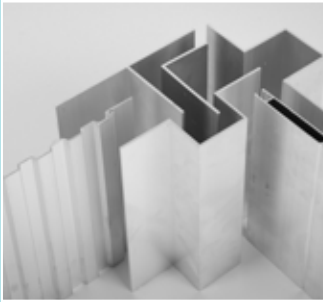

Fassadenbau  
Facade Construction /  
Building

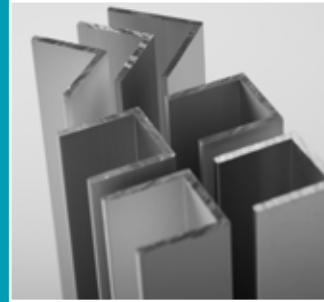

Glasbau  
Glass Construction /  
Building



Metallbau  
Metal Construction



Solar- und  
Photovoltaik-Profil  
Solar / Photovoltaic  
Profiles



Sonnen- und  
Insektenschutz  
Sun and Insect  
Protection

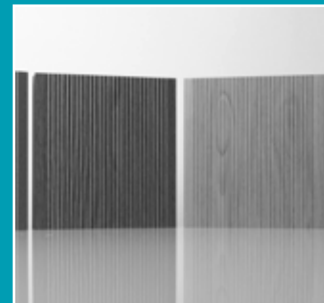

Terrassenbau  
Terrace Construction /  
Building



Tischlerei / Möbelbau  
Carpentry /  
Furniture Construction

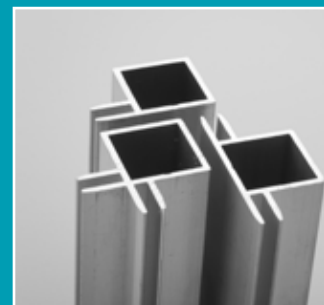

Volierenbau  
Aviary Construction



Sonstige  
Other

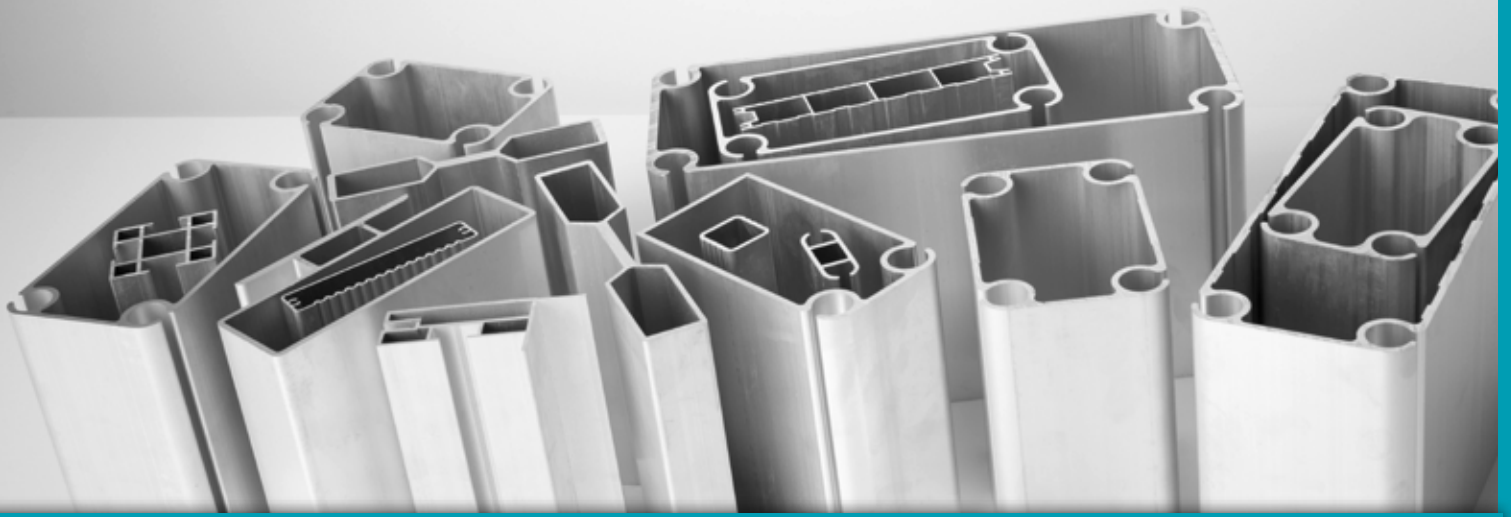

## Bühnen- und Zeltbau • Stage Construction / Tent Construction

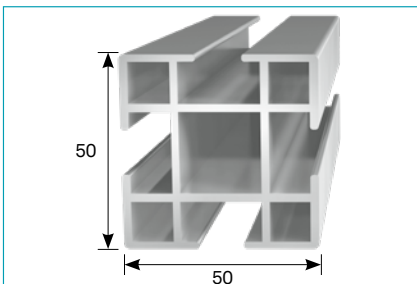

**Teleskopprofil • Telescope Profile**

Bezeichnung Designation	<b>P10054</b>
Abmessung Dimension	50 x 50 x 2 mm
Länge Length	6000 mm
Legierung Alloy	EN AW-6060 T66 (AlMgSi)
Info	Passend in Formrohr 55 x 55 x 2 mm · Fits into square tube 55 x 55 x 2 mm

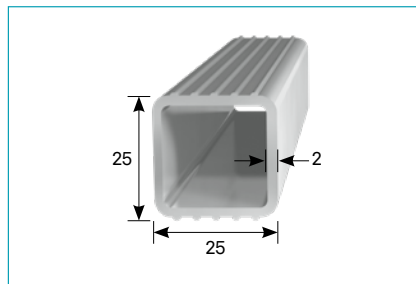

**Leitersprosse • Rung**

Bezeichnung Designation	<b>P163</b>
Abmessung Dimension	25 x 25 x 2 mm
Länge Length	6000 mm
Legierung Alloy	EN AW-6060 T66 (AlMgSi)

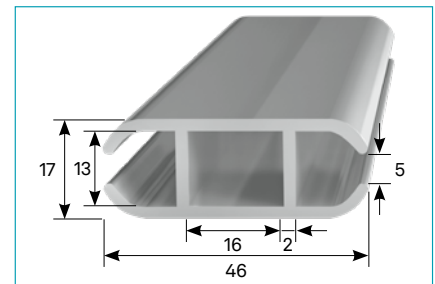

**Kederleiste • Channel Rail**

Bezeichnung Designation	<b>P2725</b>
Abmessung Dimension	46 x 17 x 2 mm
Länge Length	6500 mm
Legierung Alloy	EN AW-6060 T66 (AlMgSi)

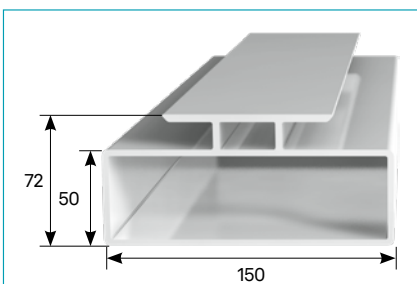

**Bodenprofil • Floor Profile**

Bezeichnung Designation	<b>P15072</b>
Abmessung Dimension	150 x 72 x 3 x 5 mm
Länge Length	5150 mm
Legierung Alloy	EN AW-6063 T6 (AlMg0,7Si)

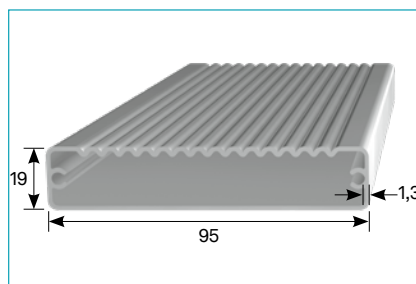

**Terrassendiele • Decking Board**

Bezeichnung Designation	<b>P9519</b>
Abmessung Dimension	95 x 19 x 1,3 mm
Länge Length	6000 mm
Legierung Alloy	EN AW-6060 T66 (AlMgSi)

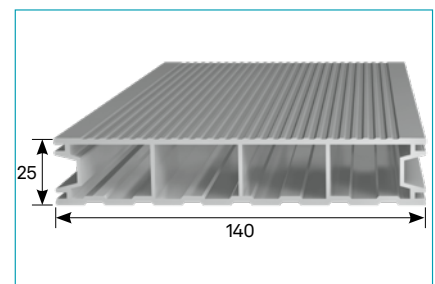

**Terrassendiele • Decking Board**

Bezeichnung Designation	<b>P14025</b>
Abmessung Dimension	140 x 25 mm
Länge Length	6000 mm
Legierung Alloy	EN AW-6060 T66 (AlMgSi)
Info	Passende Flachstange · Matching Flat Bar: 15 x 2 mm (EN AW-6060 T66 (AlMgSi))

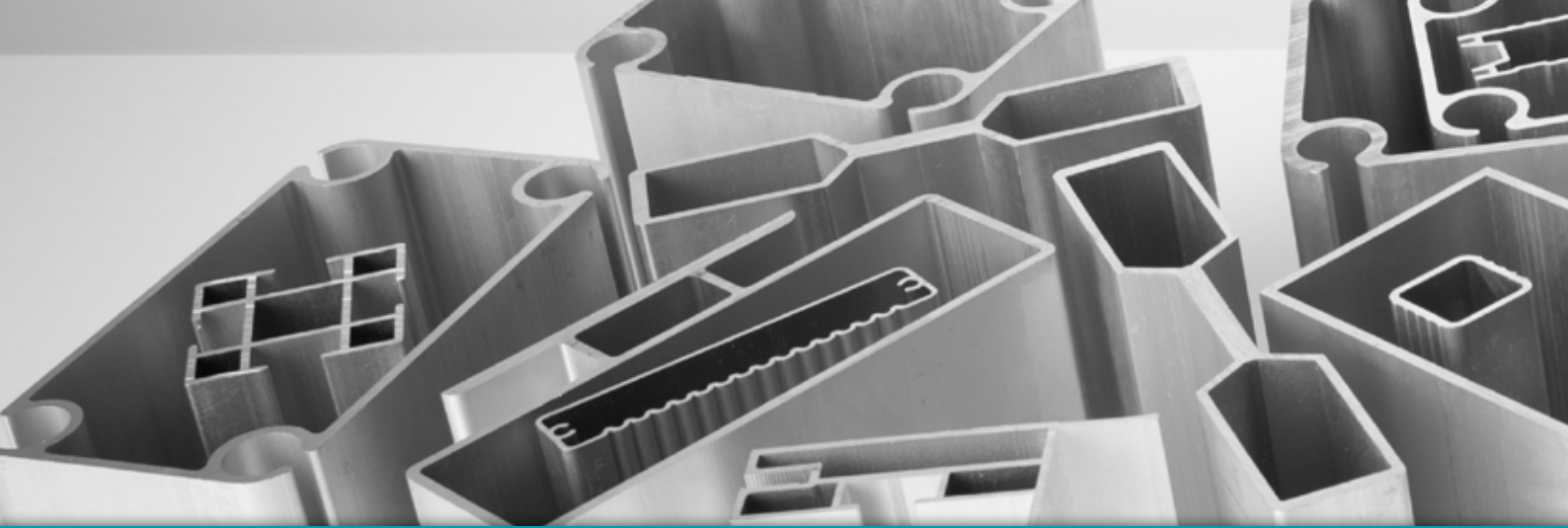

## Bühnen- und Zeltbau • Stage Construction / Tent Construction

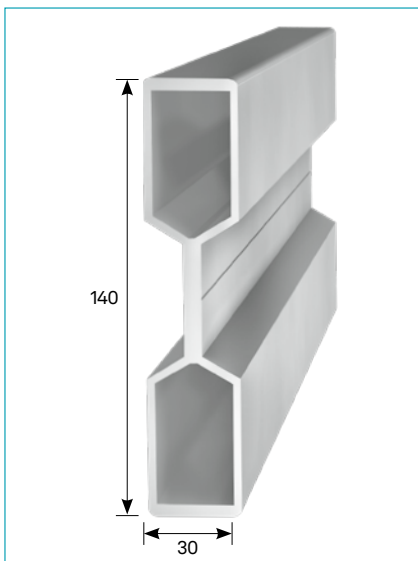

**Zarge • Architrave**

Bezeichnung Designation	<b>PZ140</b>
Abmessung Dimension	140 x 30 mm
Länge Length	6000 mm
Legierung Alloy	EN AW-6060 T66 (AlMgSi)

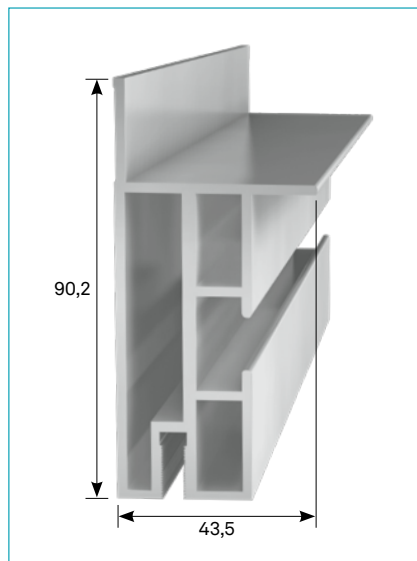

**Trägerprofil • Frame Profile**

Bezeichnung Designation	<b>P10077</b>
Abmessung Dimension	90,2 x 43,5 mm
Länge Length	6100 mm
Legierung Alloy	EN AW-6060 T66 (AlMgSi)

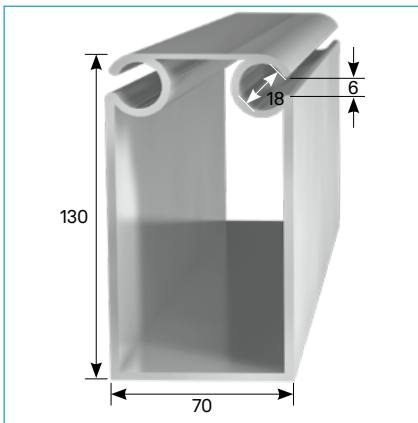
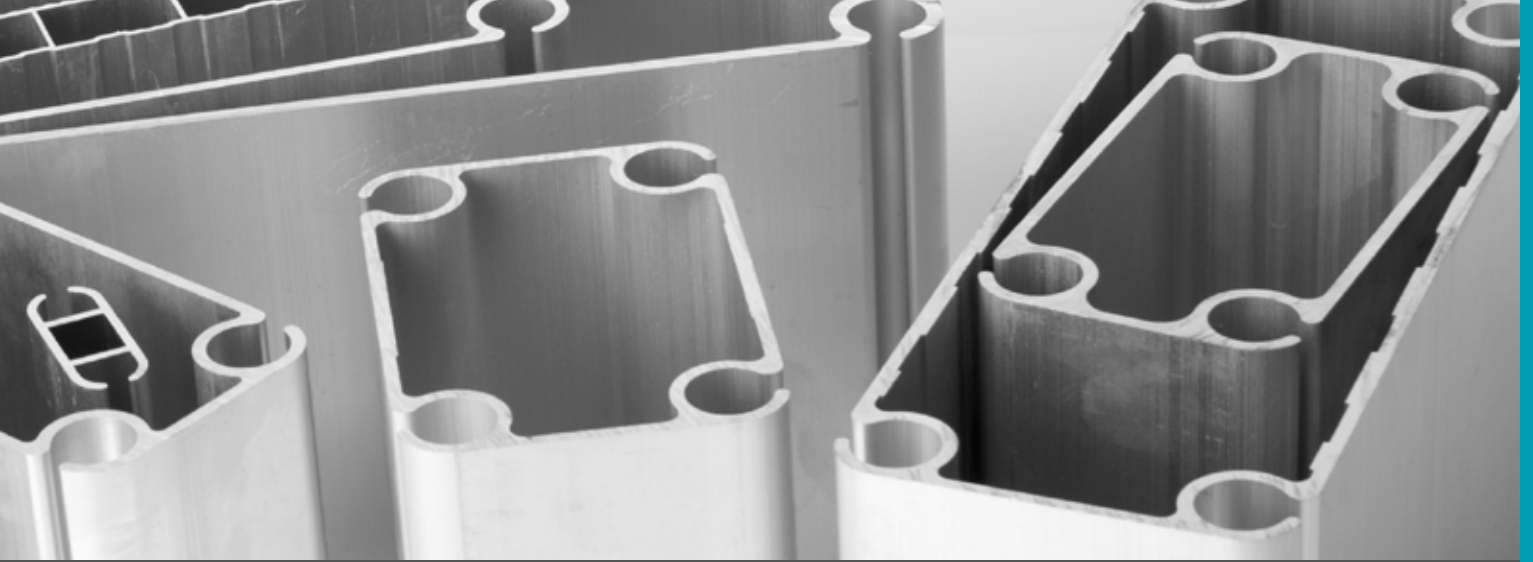

Zeltbauprofil • Tent Construction Profile	
Bezeichnung Designation	<b>P1372</b>
Abmessung Dimension	130 x 70 x 3 mm
Länge Length	8000 mm
Legierung Alloy	EN AW-6005A T6 (AlSiMg(A))

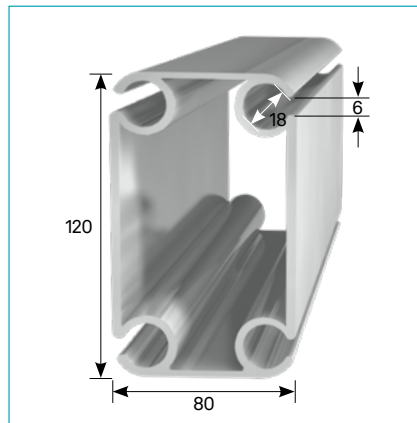

Zeltbauprofil • Tent Construction Profile	
Bezeichnung Designation	<b>P12084</b>
Abmessung Dimension	120 x 80 x 3,5 mm
Länge Length	8000 mm
Legierung Alloy	EN AW-6082 T6 (AlSi1MgMn)

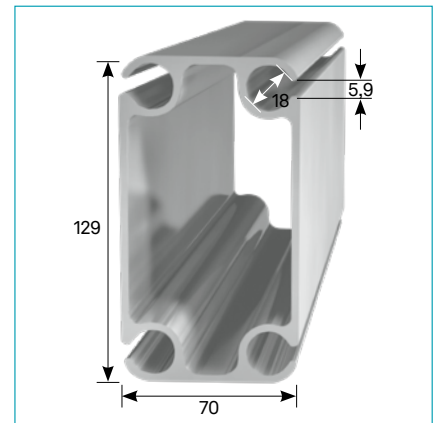

Zeltbauprofil • Tent Construction Profile	
Bezeichnung Designation	<b>P13741</b>
Abmessung Dimension	129 x 70 x 3 mm
Länge Length	8000 mm
Legierung Alloy	EN AW-6005A T6 (AlSiMg(A))

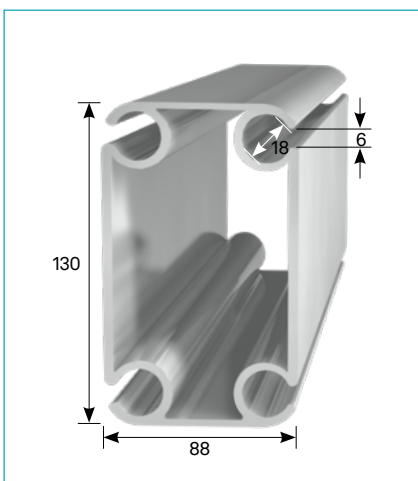

Zeltbauprofil • Tent Construction Profile	
Bezeichnung Designation	<b>P1388</b>
Abmessung Dimension	130 x 88 x 3 mm
Länge Length	8000 mm
Legierung Alloy	EN AW-6005A T6 (AlSiMg(A))

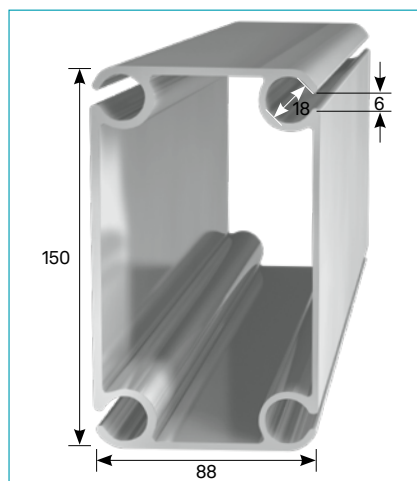

Zeltbauprofil • Tent Construction Profile	
Bezeichnung Designation	<b>P1594</b>
Abmessung Dimension	150 x 88 x 3 mm
Länge Length	8000 mm
Legierung Alloy	EN AW-6005A T6 (AlSiMg(A))

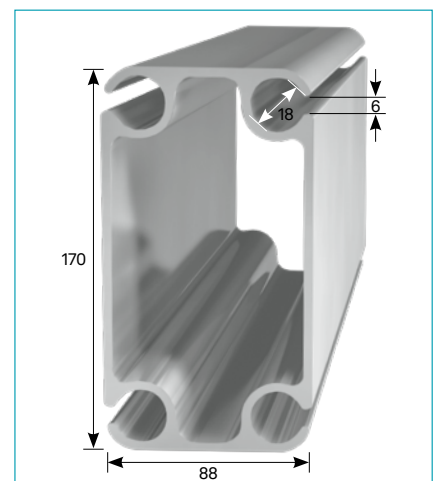

Zeltbauprofil • Tent Construction Profile	
Bezeichnung Designation	<b>P1788</b>
Abmessung Dimension	170 x 88 x 3 mm
Länge Length	8000 mm
Legierung Alloy	EN AW-6005A T6 (AlSiMg(A))



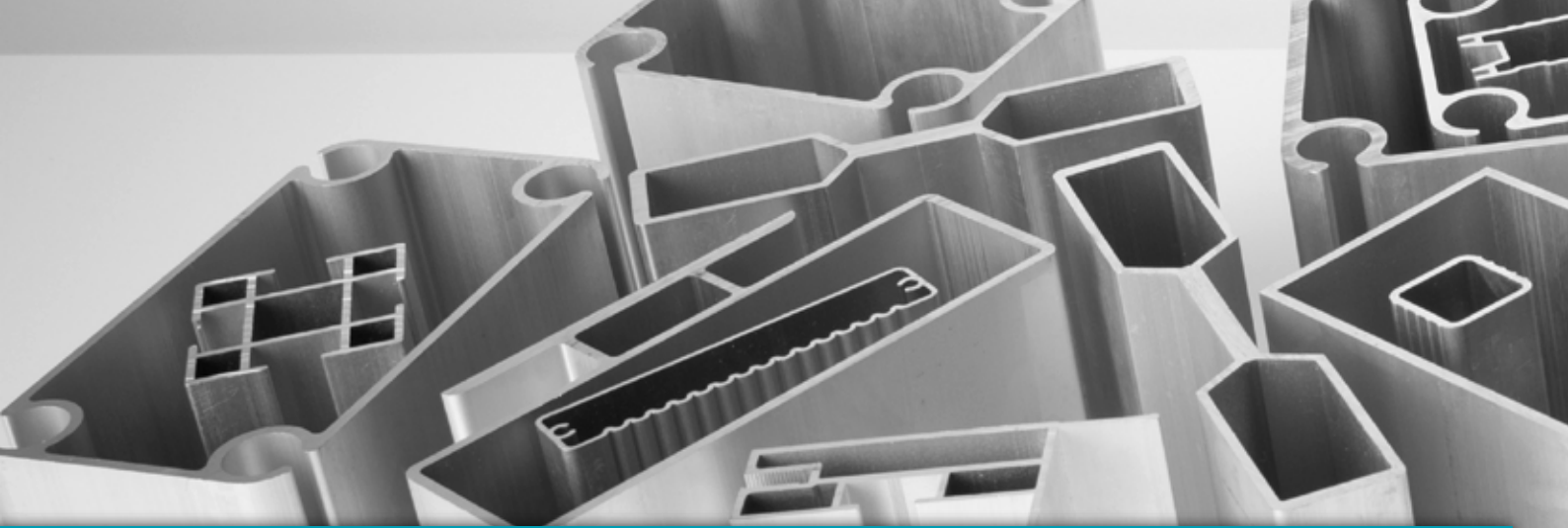

## Bühnen- und Zeltbau • Stage Construction / Tent Construction

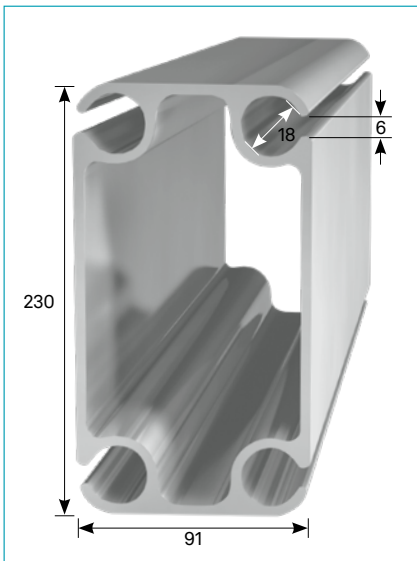

**Zeltbauprofil •  
Tent Construction Profile**

Bezeichnung Designation	<b>P2394</b>
Abmessung Dimension	230 x 91 x 3 mm
Länge Length	8000 mm
Legierung Alloy	EN AW-6005A T6 (AlSiMg(A))

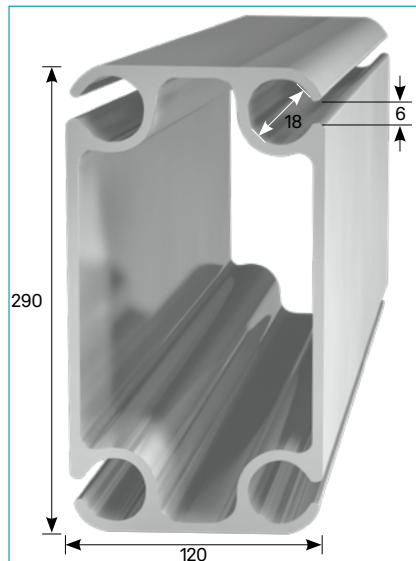

**Zeltbauprofil •  
Tent Construction Profile**

Bezeichnung Designation	<b>P2912</b>
Abmessung Dimension	290 x 120 x 5 mm
Länge Length	8000 mm
Legierung Alloy	EN AW-6082 T6 (AlSi1Mg)



## Fahrzeugbau • Vehicle Construction

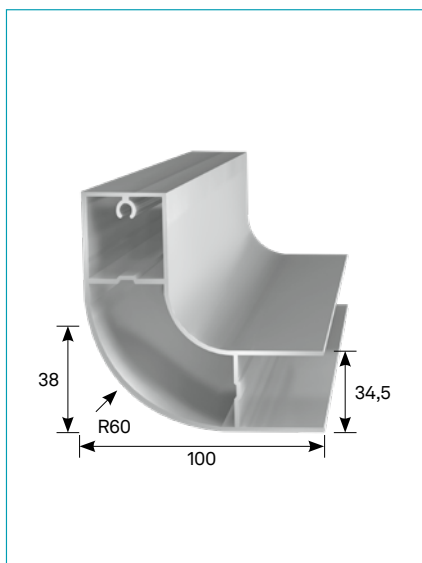

**Abweiser • Rejection Profile**

Bezeichnung Designation	<b>P9160</b>
Abmessung Dimension	100 x 100 x 34,5 x 1,8 mm
Länge Length	6100 mm
Legierung Alloy	EN AW-6060 T66 (AlMgSi)
Info	Eloxiert E6/C0 10–15 µm · Anodized E6/C0 10–15 µm

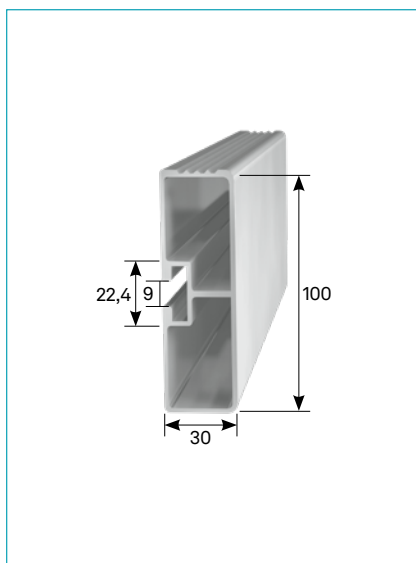

**Unterfahrschutz •  
Cycle Protection Profile**

Bezeichnung Designation	<b>P9161</b>
Abmessung Dimension	100 x 30 x 2 mm
Länge Length	7000 mm
Legierung Alloy	EN AW-6060 T66 (AlMgSi)
Info	Eloxiert E6/C0 10–12 µm · Anodized E6/C0 10–12 µm

Passende Artikel für den Tankwagenbau finden Sie ab Seite 122 ·  
Suitable items for tank truck construction see from page 122

# Fassadenbau • Facade Construction / Building

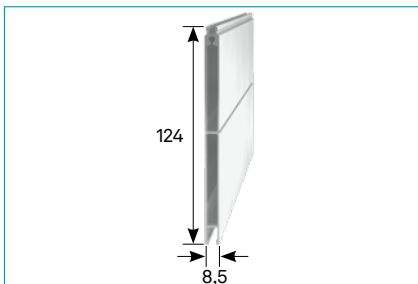

**Sichtschutzprofil • Sight Protection Profile**

Bezeichnung Designation	<b>P9279</b>
Abmessung Dimension	124 x 8,5 mm
Länge Length	6000 mm, 6500 mm
Legierung Alloy	EN AW-6060 T66 (AlMgSi)

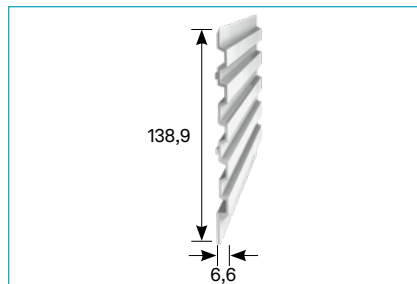

**Verkleidungsprofil • Sight Protection Profile**

Bezeichnung Designation	<b>P9256</b>
Abmessung Dimension	138,9 x 6,6 mm
Länge Length	6000 mm
Legierung Alloy	EN AW-6060 T66 (AlMgSi)

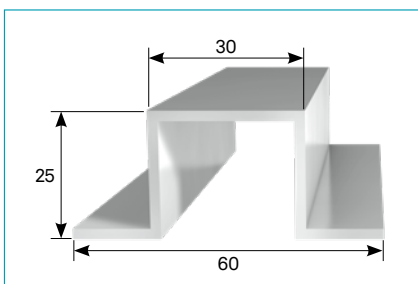
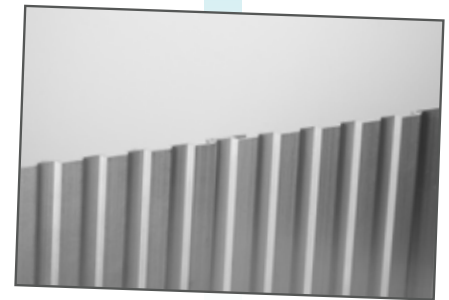
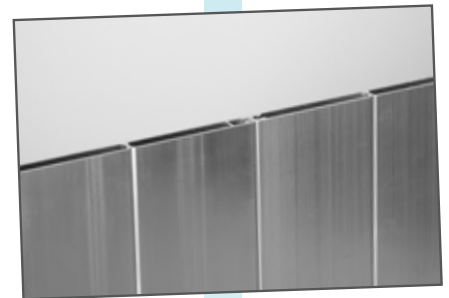

**Omega-Profil • Omega Profile**

Bezeichnung Designation	-
Abmessung Dimension	17 x 25 x 30 x 25 x 17 x 2 mm
Länge Length	6000 mm
Legierung Alloy	EN AW-6060 T66 (AlMgSi)

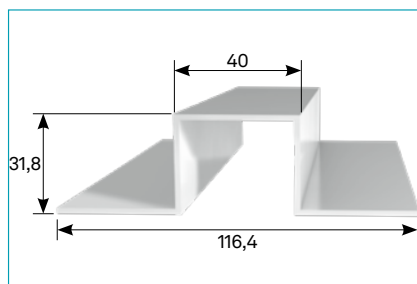

**Omega-Profil • Omega Profile**

Bezeichnung Designation	-
Abmessung Dimension	40 x 31,8 x 40 x 31,8 x 40 x 1,8 mm
Länge Length	6000 mm
Legierung Alloy	EN AW-6060 T66 (AlMgSi)

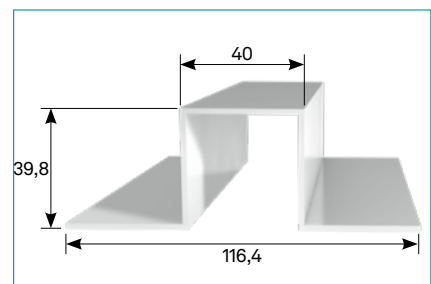

**Omega-Profil • Omega Profile**

Bezeichnung Designation	-
Abmessung Dimension	40 x 39,8 x 40 x 39,8 x 40 x 1,8 mm
Länge Length	6000 mm
Legierung Alloy	EN AW-6060 T66 (AlMgSi)



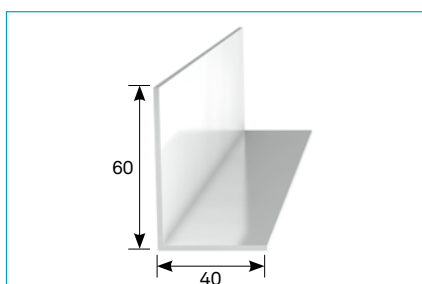
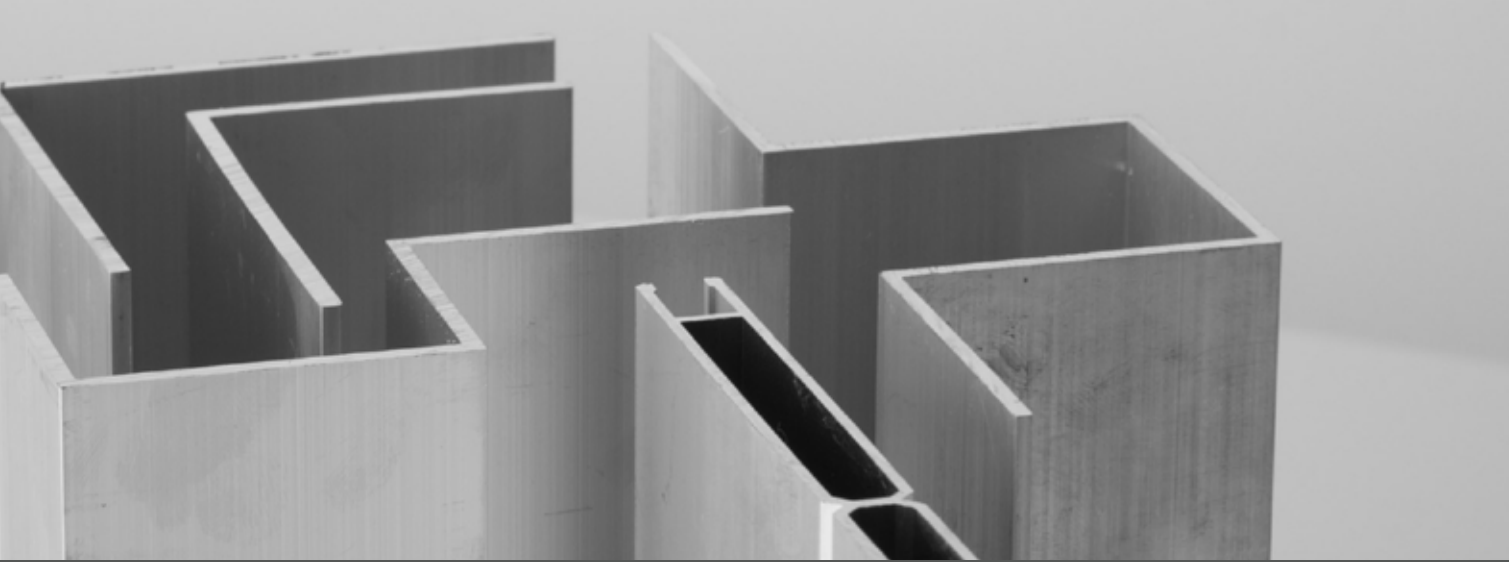

**Winkel • Angle**

Bezeichnung Designation	-
Abmessung Dimension	60 x 40 x 2 mm
Länge Length	6000 mm
Legierung Alloy	EN AW-6063 T66 (AlMg0,7Si)

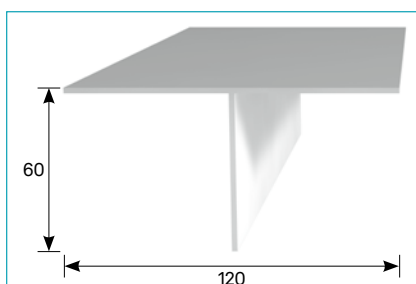

**T-Profil • T-Profile**

Bezeichnung Designation	-
Abmessung Dimension	60 x 120 x 2 mm
Länge Length	6000 mm
Legierung Alloy	EN AW-6063 T66 (AlMg0,7Si)

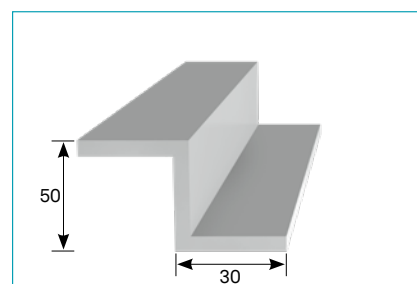

**Z-Profil • Z-Profile**

Bezeichnung Designation	-
Abmessung Dimension	30 x 50 x 30 x 2 mm
Länge Length	6000 mm
Legierung Alloy	EN AW-6063 T66 (AlMg0,7Si)

**Passende Standardprofile für den Fassadenbau • Matching Standard Profiles for Facade Construction / Building**



**Winkel • Angles**

A x B x S	Länge Length	kg/m
60 x 40 x 1,8 mm	6000 mm	0,477
60 x 40 x 2 mm	6000 mm	0,529
EN AW-6060 T66 (AlMgSi)		



**T-Profil • T-Sections**

A x B x S	Länge Length	kg/m
60 x 120 x 1,6 mm	6000 mm	0,771
60 x 120 x 2 mm	6000 mm	0,961
EN AW-6060 T66 (AlMgSi)		



**Z-Profil • Z-Sections**

A x B x S	Länge Length	kg/m
40 x 31,8 x 40 x 1,8 mm	6000 mm	0,526
50 x 39,8 x 50 x 1,8 mm	6000 mm	0,662
EN AW-6060 T66 (AlMgSi)		

# Glasbau • Glass Construction / Building

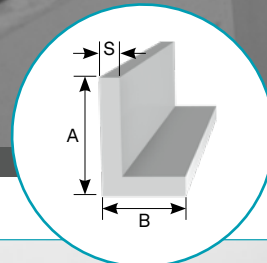

**Winkel eloxiert E6/C0 15 µm ·  
Angles anodized E6/C0 15 µm**

A x B x S	Länge Length	kg/m
20 x 20 x 2 mm	6150 mm	0,205
25 x 25 x 2 mm	6150 mm	0,259
30 x 20 x 2 mm	6150 mm	0,259
30 x 30 x 2 mm	6150 mm	0,313
40 x 20 x 2 mm	6150 mm	0,313
40 x 40 x 2 mm	6150 mm	0,421
EN AW-6060 T66 (AlMgSi)		

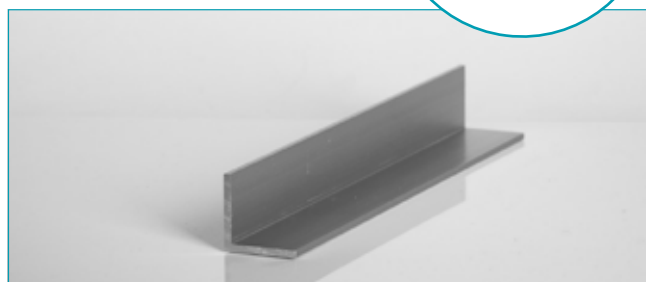

**Winkel eloxiert „Edelstahloptik“ ·  
Angles anodized “stainless steel optic”**

A x B x S	Länge Length	kg/m
20 x 20 x 2 mm	6150 mm	0,205
30 x 30 x 2 mm	6150 mm	0,313
EN AW-6060 T66 (AlMgSi)		



**Winkel beschichtet RAL 9010 65 µm ·  
Angles powder coated RAL 9010 65 µm**

A x B x S	Länge Length	kg/m
20 x 20 x 2 mm	6150 mm	0,205
30 x 30 x 2 mm	6150 mm	0,313
EN AW-6060 T66 (AlMgSi)		

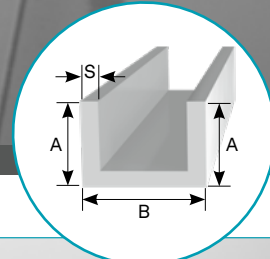
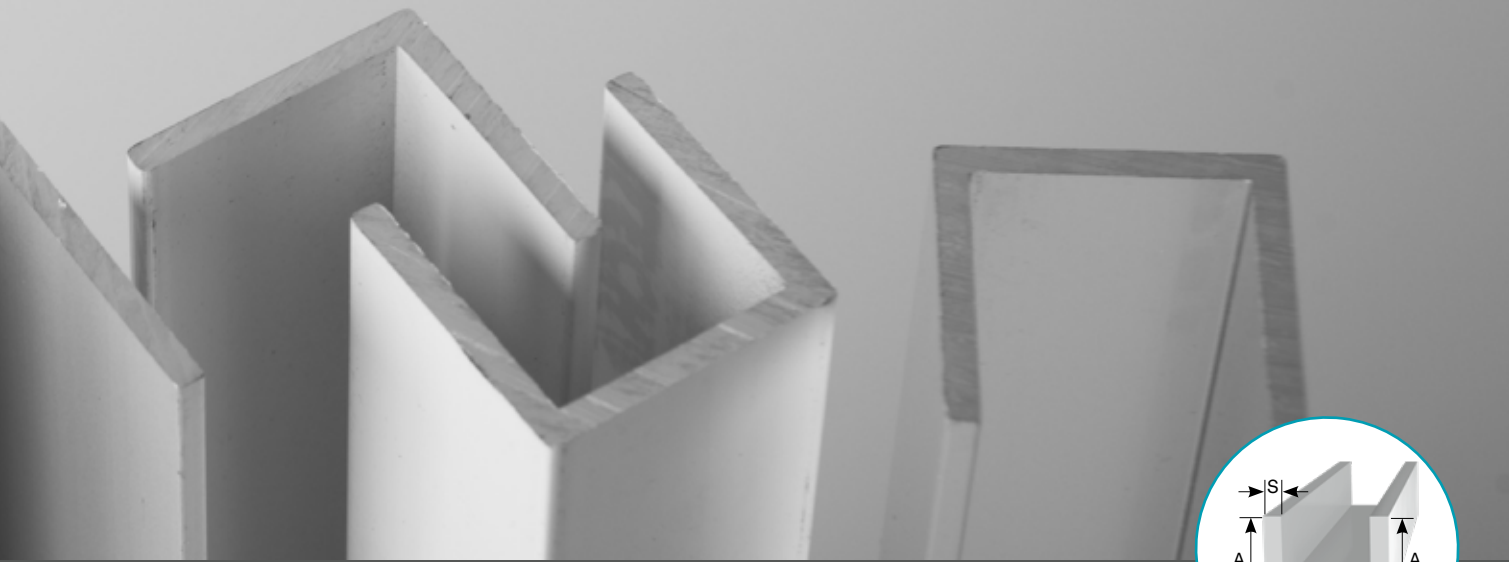

**U-Profil eloxiert E6/C0 15 µm ·  
U-Profiles anodized E6/C0 15 µm**

A x B x S	Länge Length	kg/m
20 x 13 x 20 x 1,25 mm	4000 mm	0,170
15 x 15 x 15 x 2 mm	6150 mm	0,221
20 x 15 x 20 x 1,5 mm	6150 mm	0,211
30 x 15 x 30 x 2 mm	6150 mm	0,383
10 x 20 x 10 x 2 mm	6150 mm	0,194
20 x 20 x 20 x 2 mm	6150 mm	0,302
30 x 20 x 30 x 2 mm	6150 mm	0,410
40 x 20 x 40 x 2 mm	6150 mm	0,518
25 x 25 x 25 x 2 mm	6150 mm	0,383
20 x 30 x 20 x 2 mm	6150 mm	0,356
30 x 30 x 30 x 2 mm	6150 mm	0,464
20 x 40 x 20 x 2 mm	6150 mm	0,410
40 x 40 x 40 x 2 mm	6150 mm	0,626

EN AW-6060 T66 (AlMgSi)



**U-Profil beschichtet RAL 9010 65 µm ·  
U-Profiles powder coated RAL 9010 65 µm**

A x B x S	Länge Length	kg/m
15 x 15 x 15 x 2 mm	6150 mm	0,221
20 x 20 x 20 x 2 mm	6150 mm	0,302
30 x 20 x 30 x 2 mm	6150 mm	0,410
40 x 20 x 40 x 2 mm	6150 mm	0,518

EN AW-6060 T66 (AlMgSi)

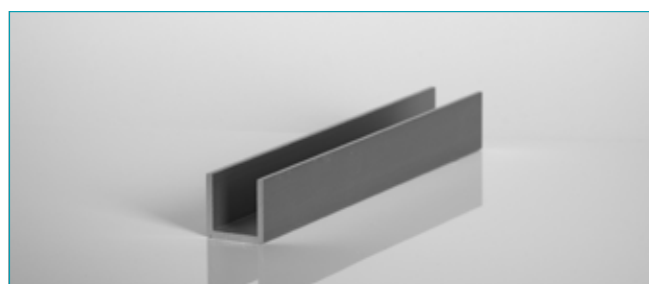

**U-Profil eloxiert „Edelstahloptik“ ·  
U-Profiles anodized “stainless steel optic”**

A x B x S	Länge Length	kg/m
15 x 15 x 15 x 2 mm	6150 mm	0,221
20 x 20 x 20 x 2 mm	6150 mm	0,302
30 x 20 x 30 x 2 mm	6150 mm	0,410
40 x 20 x 40 x 2 mm	6150 mm	0,518

EN AW-6060 T66 (AlMgSi)

Durch das nicht genormte Verfahren sind Farbunterschiede bei unterschiedlichen Chargen möglich.

The non-standard method allows color differences for different batches.

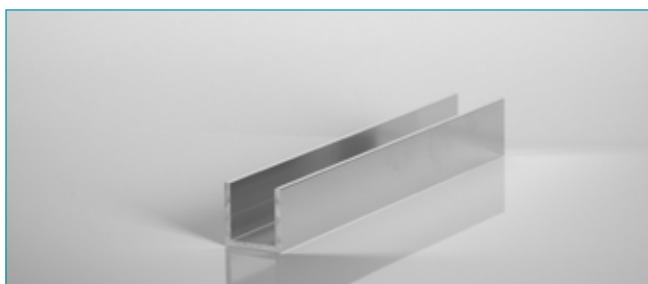

**U-Profil glanzeloxiert E8/C0 15 µm ·  
U-Profiles shiny anodized E8/C0 15 µm**

A x B x S	Länge Length	kg/m
15 x 15 x 15 x 2 mm	4000 mm	0,221
20 x 20 x 20 x 2 mm	4000 mm	0,302

EN AW-6060 T66 (AlMgSi)

## Metallbau • Metal Construction

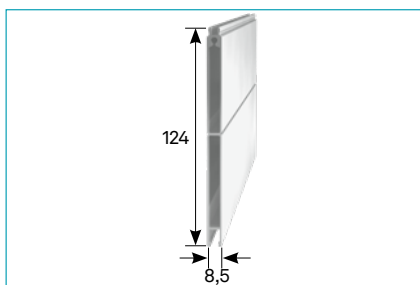

**Sichtschutzprofil •  
Sight Protection Profile**

Bezeichnung Designation	<b>P9279</b>
Abmessung Dimension	124 x 8,5 mm
Länge Length	6000 mm, 6500 mm
Legierung Alloy	EN AW-6060 T66 (AlMgSi)

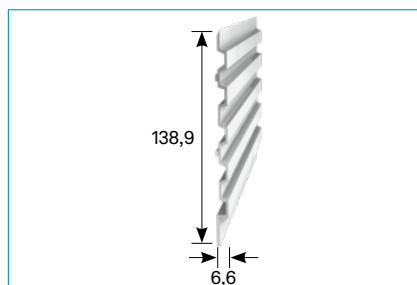

**Verkleidungsprofil •  
Sight Protection Profile**

Bezeichnung Designation	<b>P9256</b>
Abmessung Dimension	138,9 x 6,6 mm
Länge Length	6000 mm
Legierung Alloy	EN AW-6060 T66 (AlMgSi)

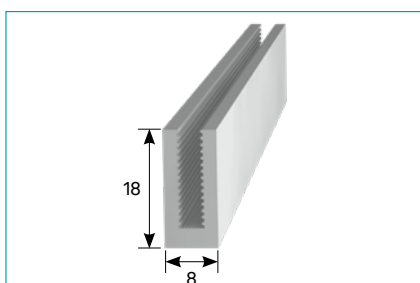
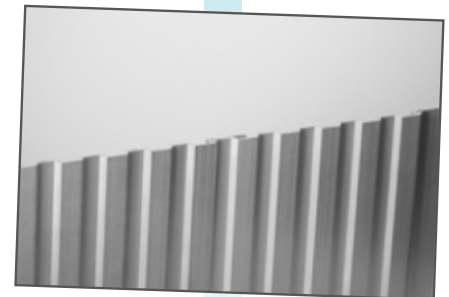
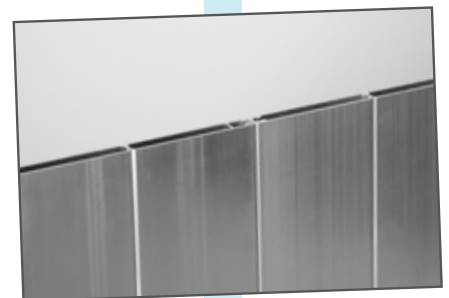

**Einfassprofil • Enclosure Profile**

Bezeichnung Designation	<b>P32</b>
Abmessung Dimension	18 x 8 x 2,4 mm
Länge Length	6000 mm
Legierung Alloy	EN AW-6060 T66 (AlMgSi)
Öffnung Opening	3,2 mm

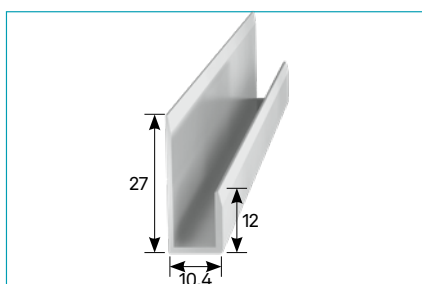

**U-Profil ungleichschenkelig • U-Profile unequal**

Bezeichnung Designation	-
Abmessung Dimension	27 x 10,4 x 12 x 1 / 1,2 mm
Länge Length	6000 mm
Legierung Alloy	EN AW-6060 T66 (AlMgSi)

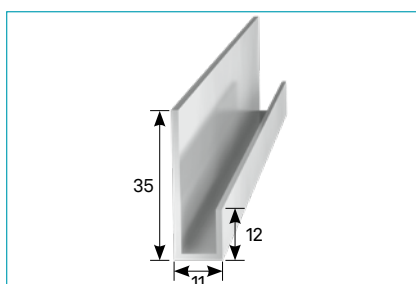

**U-Profil ungleichschenkelig • U-Profile unequal**

Bezeichnung Designation	-
Abmessung Dimension	35 x 11 x 12 x 1,5 mm
Länge Length	6000 mm
Legierung Alloy	EN AW-6060 T66 (AlMgSi)

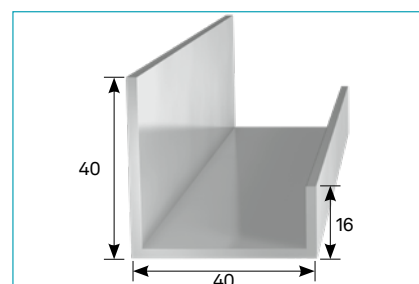

**U-Profil ungleichschenkelig • U-Profile unequal**

Bezeichnung Designation	-
Abmessung Dimension	40 x 40 x 16 x 2 mm
Länge Length	6000 mm
Legierung Alloy	EN AW-6060 T66 (AlMgSi)

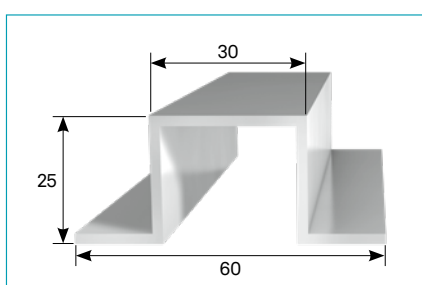

**Omega-Profil • Omega Profile**

Bezeichnung Designation	-
Abmessung Dimension	17 x 25 x 30 x 25 x 17 x 2 mm
Länge Length	6000 mm
Legierung Alloy	EN AW-6060 T66 (AlMgSi)

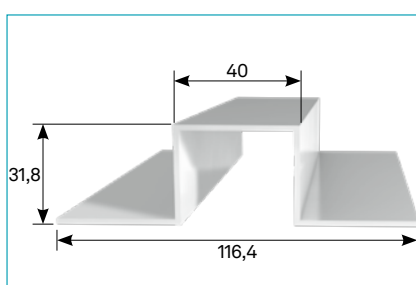

**Omega-Profil • Omega Profile**

Bezeichnung Designation	-
Abmessung Dimension	40 x 31,8 x 40 x 31,8 x 40 x 1,8 mm
Länge Length	6000 mm
Legierung Alloy	EN AW-6060 T66 (AlMgSi)

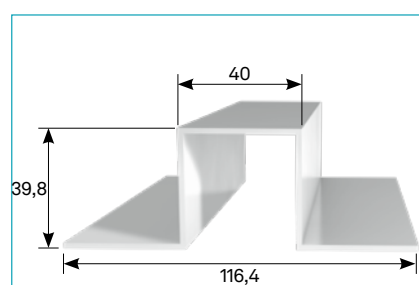

**Omega-Profil • Omega Profile**

Bezeichnung Designation	-
Abmessung Dimension	40 x 39,8 x 40 x 39,8 x 40 x 1,8 mm
Länge Length	6000 mm
Legierung Alloy	EN AW-6060 T66 (AlMgSi)



# Metallbau • Metal Construction

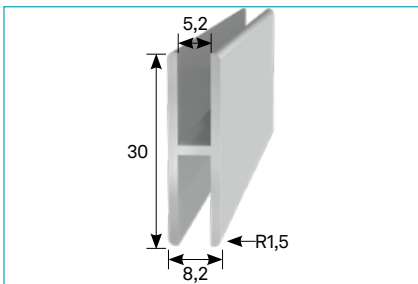

**H-Profil • H-Section**

Bezeichnung Designation	<b>P20160</b>
Abmessung Dimension	30 x 8,2 x 1,5 mm
Länge Length	6000 mm
Legierung Alloy	EN AW-6060 T66 (AlMgSi)
Öffnung Opening	5,2 mm

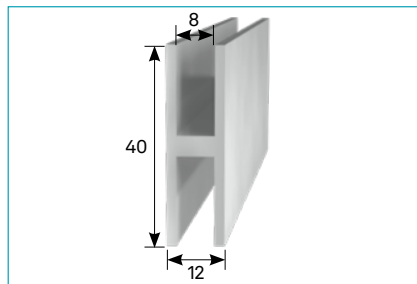

**H-Profil • H-Section**

Bezeichnung Designation	<b>P12</b>
Abmessung Dimension	40 x 12 x 2 x 4 mm
Länge Length	6000 mm
Legierung Alloy	EN AW-6060 T66 (AlMgSi)
Öffnung Opening	8 mm

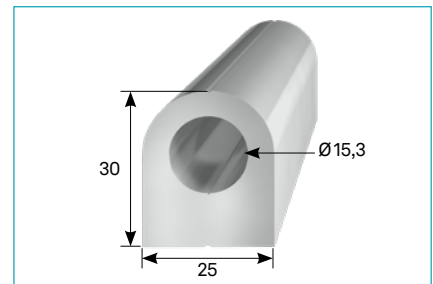

**Scharnier- und Riegelprofil •  
Hinge and Bolt Profile**

Bezeichnung Designation	<b>P05</b>
Abmessung Dimension	30 x 25 mm
Länge Length	6000 mm
Loch-Dm. Hole-Diam.	15,3 mm
Achsabstand Axle-base	18 mm

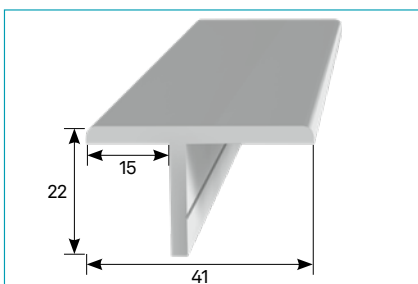

**T-Profil • T-Profile**

Bezeichnung Designation	<b>P41</b>
Abmessung Dimension	41 x 22 x 3 mm
Länge Length	6000 mm
Legierung Alloy	EN AW-6060 T66 (AlMgSi)

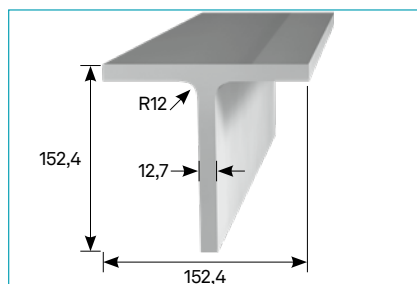

**T-Profil mit Radius •  
T-Section with radius**

Bezeichnung Designation	-
Abmessung Dimension	152,4 x 152,4 x 12,7 mm
Länge Length	6000 mm
Legierung Alloy	EN AW-6082 T6 (AlSi1MgMn)
Radius	12 mm

**Weitere T-Profile und H-Profile ab Seite 19  
For more T-Sections and H-Sections see from page 19**

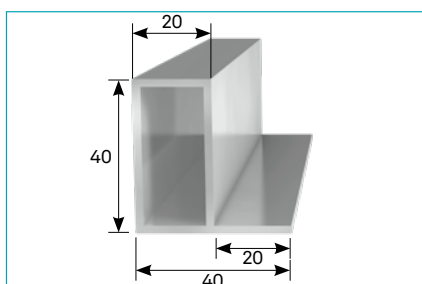

**Faltstegprofil • Folding Bar Profile**

Bezeichnung Designation	<b>P420</b>
Abmessung Dimension	40 x 40 x 20 x 2 mm
Länge Length	6000 mm
Legierung Alloy	EN AW-6060 T66 (AlMgSi)

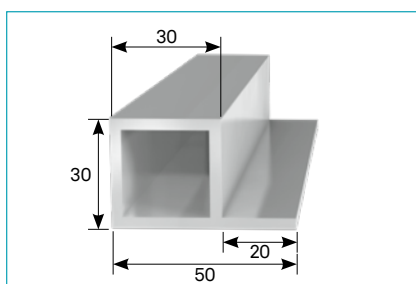

**Faltstegprofil • Folding Bar Profile**

Bezeichnung Designation	<b>P513</b>
Abmessung Dimension	50 x 30 x 30 x 3 mm
Länge Length	6000 mm
Legierung Alloy	EN AW-6060 T66 (AlMgSi)

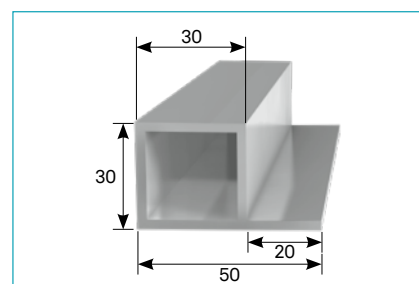

**Faltstegprofil • Folding Bar Profile**

Bezeichnung Designation	<b>P51</b>
Abmessung Dimension	50 x 30 x 30 x 2 mm
Länge Length	6000 mm
Legierung Alloy	EN AW-6060 T66 (AlMgSi)

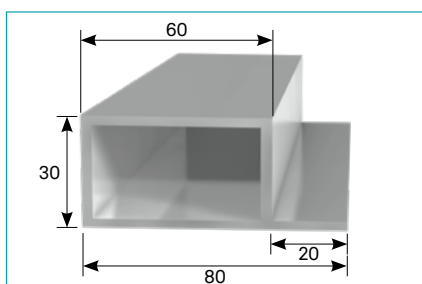

**Faltstegprofil • Folding Bar Profile**

Bezeichnung Designation	<b>P83</b>
Abmessung Dimension	80 x 60 x 30 x 2 mm
Länge Length	6000 mm
Legierung Alloy	EN AW-6060 T66 (AlMgSi)

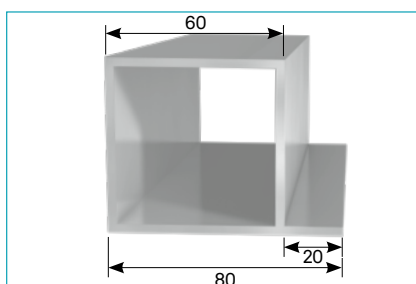

**Faltstegprofil • Folding Bar Profile**

Bezeichnung Designation	<b>P661</b>
Abmessung Dimension	80 x 60 x 60 x 3 mm
Länge Length	6000 mm
Legierung Alloy	EN AW-6060 T66 (AlMgSi)

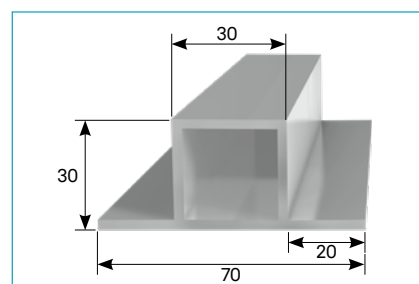

**Faltstegprofil • Folding Bar Profile**

Bezeichnung Designation	<b>P73</b>
Abmessung Dimension	70 x 30 x 30 x 2 mm
Länge Length	6000 mm
Legierung Alloy	EN AW-6060 T66 (AlMgSi)

# Metallbau • Metal Construction

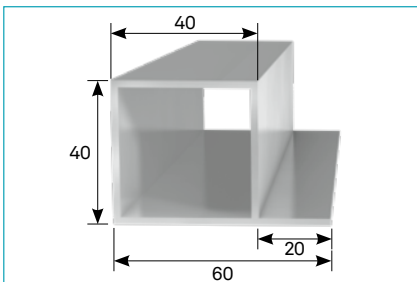

**Faltstegprofil • Folding Bar Profile**

Bezeichnung Designation	<b>P441</b>
Abmessung Dimension	60 x 40 x 40 x 2 mm
Länge Length	6000 mm
Legierung Alloy	EN AW-6060 T66 (AlMgSi)

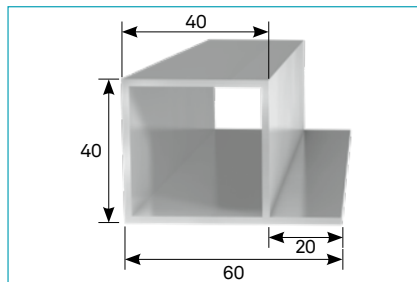

**Faltstegprofil • Folding Bar Profile**

Bezeichnung Designation	<b>P443</b>
Abmessung Dimension	60 x 40 x 40 x 3 mm
Länge Length	6000 mm
Legierung Alloy	EN AW-6060 T66 (AlMgSi)

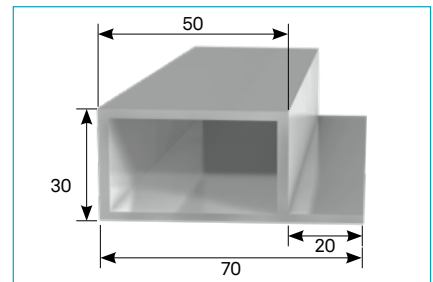

**Faltstegprofil • Folding Bar Profile**

Bezeichnung Designation	<b>P70</b>
Abmessung Dimension	70 x 50 x 30 x 2 mm
Länge Length	6000 mm
Legierung Alloy	EN AW-6060 T66 (AlMgSi)

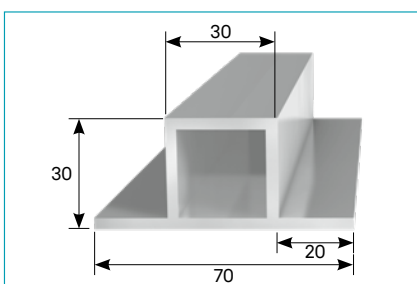

**Faltstegprofil • Folding Bar Profile**

Bezeichnung Designation	<b>P733</b>
Abmessung Dimension	70 x 30 x 30 x 3 mm
Länge Length	6000 mm
Legierung Alloy	EN AW-6060 T66 (AlMgSi)

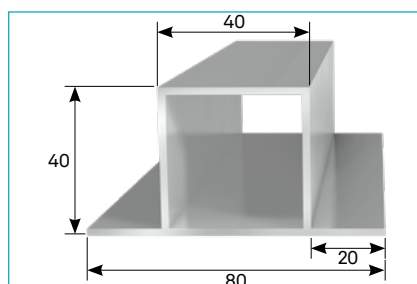

**Faltstegprofil • Folding Bar Profile**

Bezeichnung Designation	<b>P442</b>
Abmessung Dimension	80 x 40 x 40 x 2 mm
Länge Length	6000 mm
Legierung Alloy	EN AW-6060 T66 (AlMgSi)

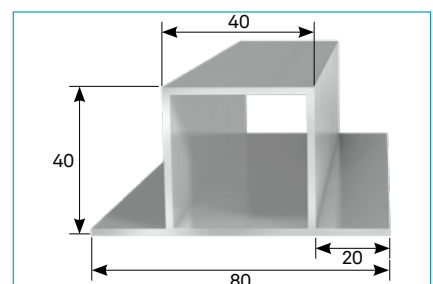

**Faltstegprofil • Folding Bar Profile**

Bezeichnung Designation	<b>P444</b>
Abmessung Dimension	80 x 40 x 40 x 3 mm
Länge Length	6000 mm
Legierung Alloy	EN AW-6060 T66 (AlMgSi)

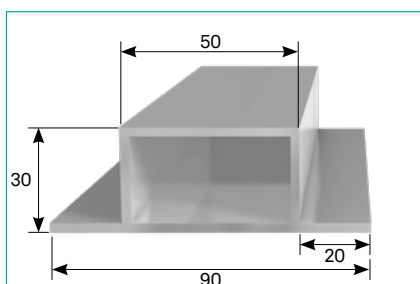

**Faltstegprofil • Folding Bar Profile**

Bezeichnung Designation	<b>P93</b>
Abmessung Dimension	90 x 50 x 30 x 1,8 / 2 mm
Länge Length	6000 mm
Legierung Alloy	EN AW-6060 T66 (AlMgSi)

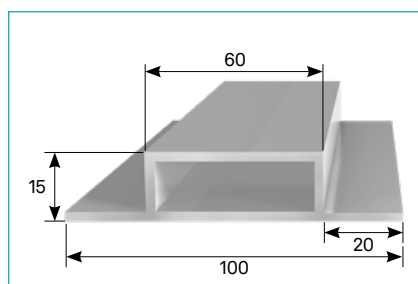

**Faltstegprofil • Folding Bar Profile**

Bezeichnung Designation	<b>P60</b>
Abmessung Dimension	100 x 60 x 15 x 2 mm
Länge Length	6000 mm
Legierung Alloy	EN AW-6060 T66 (AlMgSi)

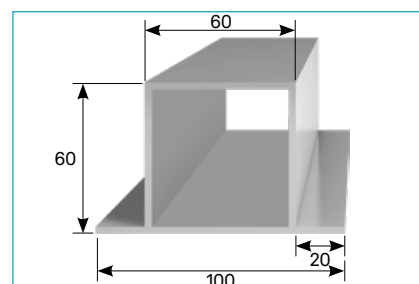

**Faltstegprofil • Folding Bar Profile**

Bezeichnung Designation	<b>P6625</b>
Abmessung Dimension	100 x 60 x 60 x 2,5 mm
Länge Length	6000 mm
Legierung Alloy	EN AW-6060 T66 (AlMgSi)

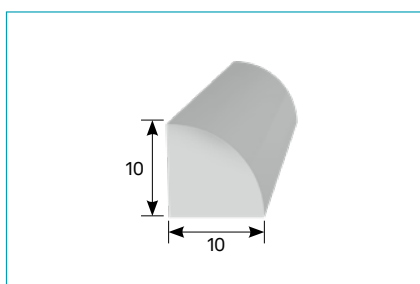

**Viertelstab • Quarter Round**

Bezeichnung Designation	<b>P100</b>
Abmessung Dimension	10 x 10 mm
Länge Length	6000 mm
Legierung Alloy	EN AW-6060 T66 (AlMgSi)
Radius	10 mm

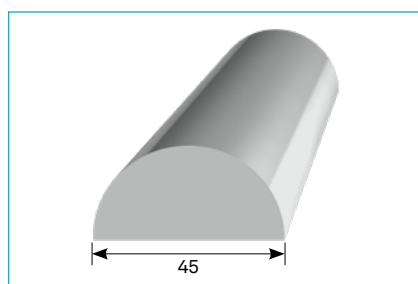

**Halbrundprofil • Semicircular Profile**

Bezeichnung Designation	-
Abmessung Dimension	45 x 20 mm
Länge Length	6000 mm
Legierung Alloy	EN AW-6060 T66 (AlMgSi)

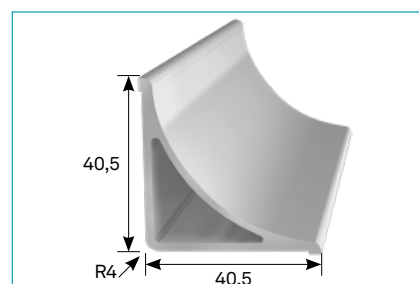

**Wandabschlussprofil •  
Connecting Walls Profile**

Bezeichnung Designation	<b>P36</b>
Abmessung Dimension	40,5 x 40,5 x 2 x 1,6 mm
Länge Length	6000 mm
Legierung Alloy	EN AW-6060 T66 (AlMgSi)

# Metallbau • Metal Construction

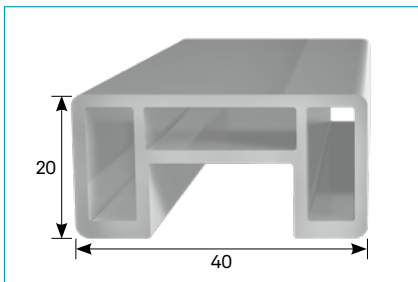

**Einfassprofil • Enclosure Profile**

Bezeichnung Designation	<b>P45</b>
Abmessung Dimension	40 x 20 x 1,8 mm
Länge Length	6000 mm
Legierung Alloy	EN AW-6060 T66 (AlMgSi)
Öffnungsbreite Opening width	19,7 mm

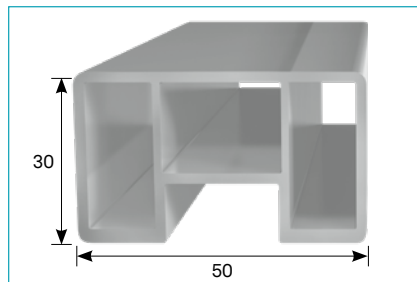

**Einfassprofil • Enclosure Profile**

Bezeichnung Designation	<b>P53</b>
Abmessung Dimension	50 x 30 x 1,8 mm
Länge Length	6000 mm
Legierung Alloy	EN AW-6060 T66 (AlMgSi)
Öffnungsbreite Opening width	19,7 mm

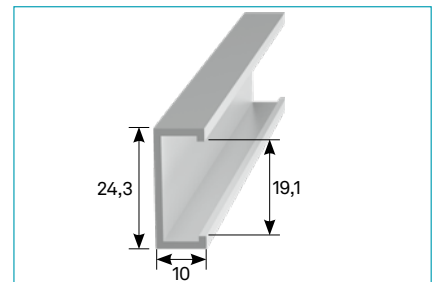

**Abdeckleiste • Cover Strip**

Bezeichnung Designation	<b>P24</b>
Abmessung Dimension	24,3 x 10 x 1,5 mm
Länge Length	5000 mm, 6000 mm, 7000 mm
Legierung Alloy	EN AW-6060 T66 (AlMgSi)
Öffnung Opening	19,1 mm

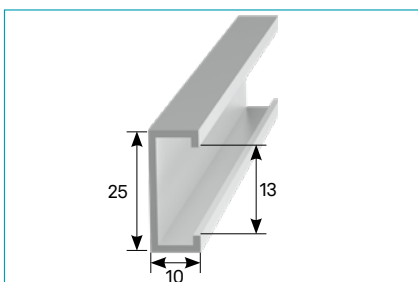

**Abdeckleiste • Cover Strip**

Bezeichnung Designation	<b>P03</b>
Abmessung Dimension	25 x 10 x 1,5 mm
Länge Length	5000 mm, 6000 mm, 7000 mm
Legierung Alloy	EN AW-6060 T66 (AlMgSi)
Öffnung Opening	18 mm

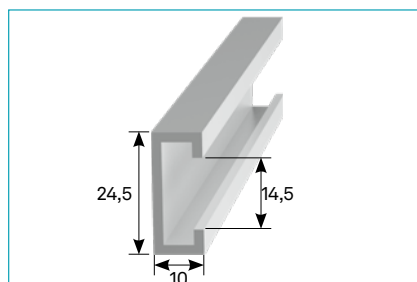

**Abdeckleiste • Cover Strip**

Bezeichnung Designation	<b>P245</b>
Abmessung Dimension	24,5 x 10 x 2 mm
Länge Length	6000 mm
Legierung Alloy	EN AW-6060 T66 (AlMgSi)
Öffnung Opening	14,5 mm

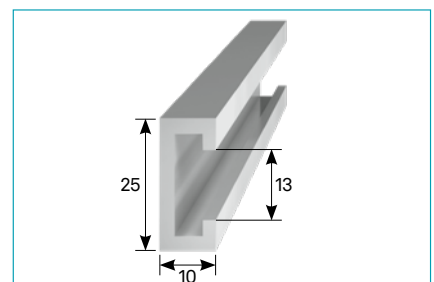

**Abdeckleiste • Cover Strip**

Bezeichnung Designation	<b>P25</b>
Abmessung Dimension	25 x 10 x 2,5 mm
Länge Length	6000 mm
Legierung Alloy	EN AW-6060 T66 (AlMgSi)
Öffnung Opening	13 mm



## Solar- und Photovoltaik-Profile • Solar / Photovoltaic Profiles

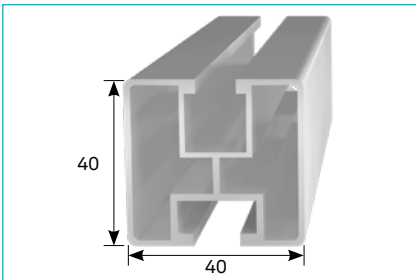

**Photovoltaikprofil / Montageschiene •  
Photovoltaic Profile / Mounting Rail Profile**

Bezeichnung Designation	<b>PV01</b>
Abmessung Dimension	40 x 40 x 1,5 mm
Länge Length	6500 mm
Legierung Alloy	EN AW-6060 T66 (AlMgSi)

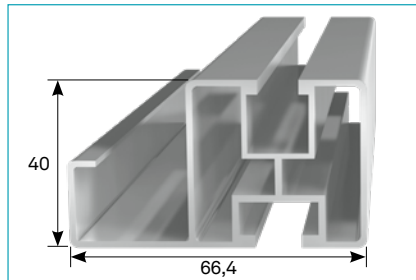

**Photovoltaikprofil / Montageschiene •  
Photovoltaic Profile / Mounting Rail Profile**

Bezeichnung Designation	<b>PV02</b>
Abmessung Dimension	66,4 x 40 x 40 x 1,5 mm
Länge Length	6500 mm
Legierung Alloy	EN AW-6060 T66 (AlMgSi)

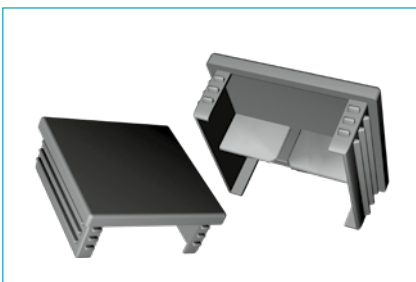

**Stopfen • Plugs**

Bezeichnung Designation	<b>für PV01 und PV02 • for PV01 and PV02</b>
Material	Kunststoff, RAL 9006 • Plastic, RAL 9006

## Sonnen- und Insektenschutz • Sun and Insect Protection

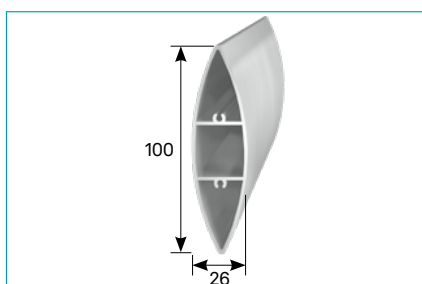

**Lamelle • Slat**

Bezeichnung Designation	<b>P10026</b>
Abmessung Dimension	100 x 26 x 1,5 mm
Länge Length	6000 mm
Legierung Alloy	EN AW-6060 T66 (AlMgSi)

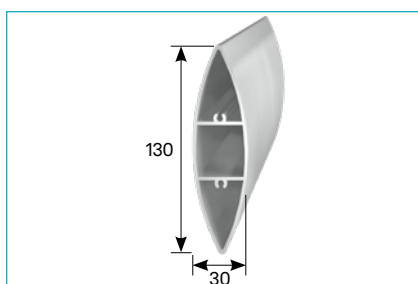

**Lamelle • Slat**

Bezeichnung Designation	<b>P13030</b>
Abmessung Dimension	130 x 30 x 1,5 mm
Länge Length	6000 mm
Legierung Alloy	EN AW-6060 T66 (AlMgSi)

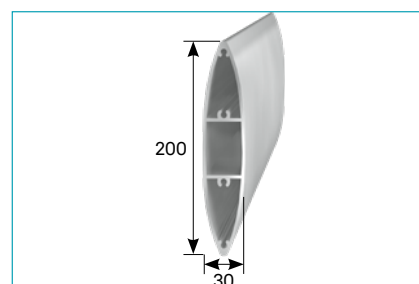

**Lamelle • Slat**

Bezeichnung Designation	<b>P20030</b>
Abmessung Dimension	200 x 30 x 2 mm
Länge Length	6000 mm
Legierung Alloy	EN AW-6060 T66 (AlMgSi)

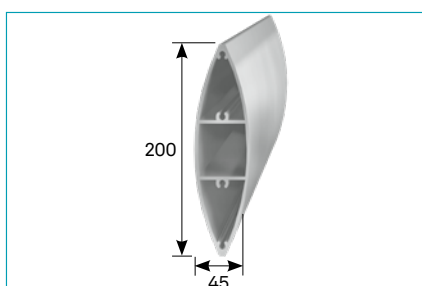

**Lamelle • Slat**

Bezeichnung Designation	<b>P20045</b>
Abmessung Dimension	200 x 45 x 2 mm
Länge Length	6000 mm
Legierung Alloy	EN AW-6060 T66 (AlMgSi)

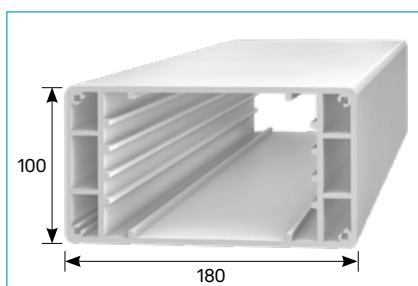

**Trägerprofil • Frame Profile**

Bezeichnung Designation	<b>P18010</b>
Abmessung Dimension	180 x 100 x 4,2 mm
Länge Length	8000 mm
Legierung Alloy	EN AW-6060 T66 (AlMgSi)

Passende U-Profile ab Seite 21 • Matching U-Profiles see from page 21

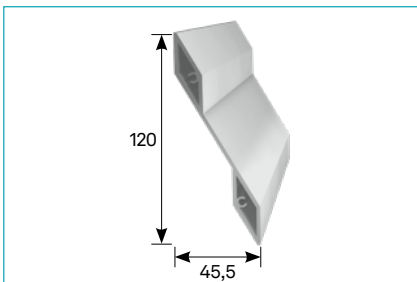

**Lamelle 30° • Slat 30°**

Bezeichnung Designation	<b>P125</b>
Abmessung Dimension	120 x 45,5 x 2 mm
Länge Length	6000 mm
Legierung Alloy	EN AW-6060 T66 (AlMgSi)

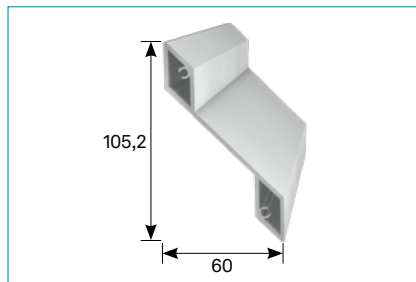

**Lamelle 45° • Slat 45°**

Bezeichnung Designation	<b>P1151</b>
Abmessung Dimension	105,2 x 60 x 2 mm
Länge Length	6000 mm
Legierung Alloy	EN AW-6060 T66 (AlMgSi)

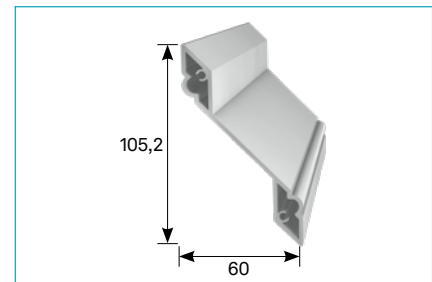

**Dekor-Lamelle 45° • Decor-Slat 45°**

Bezeichnung Designation	<b>P1152</b>
Abmessung Dimension	105,2 x 60 x 2 mm
Länge Length	6000 mm
Legierung Alloy	EN AW-6060 T66 (AlMgSi)

**Montagemöglichkeit mit folgenden U-Profilen • Mounting option with following U-Profiles**

Lamelle 30° P125 Slat 30° P125		
A x B x A x S	Länge Length	kg/m
50 x 50 x 50 x 2 mm	6000 mm	0,788
30 x 50 x 30 x 2 mm	6000 mm	0,572
25 x 50 x 25 x 2 mm	6000 mm	0,518
20 x 50 x 20 x 2 mm	6000 mm	0,464
50 x 30 x 50 x 3 mm	6000 mm	1,010
40 x 30 x 40 x 3 mm	6000 mm	0,842
30 x 30 x 30 x 3 mm	6000 mm	0,680
20 x 30 x 20 x 3 mm	6000 mm	0,518
EN AW-6060 T66 (AlMgSi)		

Lamelle 45° P1151 Slat 45° P1151		
A x B x A x S	Länge Length	kg/m
25 x 65 x 25 x 2,5 mm	6000 mm	0,743
55 x 65 x 55 x 2,5 mm	6000 mm	1,148
60 x 40 x 60 x 3 mm	6000 mm	1,247
40 x 40 x 40 x 3 mm	6000 mm	0,923
30 x 40 x 30 x 3 mm	6000 mm	0,761
25 x 40 x 25 x 3 mm	6000 mm	0,680
20 x 40 x 20 x 3 mm	6000 mm	0,599
EN AW-6060 T66 (AlMgSi)		

Dekor-Lamelle 45° P1152 Slat for decoration 45° P1152		
A x B x A x S	Länge Length	kg/m
25 x 65 x 25 x 2,5 mm	6000 mm	0,743
55 x 65 x 55 x 2,5 mm	6000 mm	1,148
60 x 40 x 60 x 3 mm	6000 mm	1,247
40 x 40 x 40 x 3 mm	6000 mm	0,923
30 x 40 x 30 x 3 mm	6000 mm	0,761
25 x 40 x 25 x 3 mm	6000 mm	0,680
20 x 40 x 20 x 3 mm	6000 mm	0,599
EN AW-6060 T66 (AlMgSi)		

## Sonnen- und Insektenschutz • Sun and Insect Protection

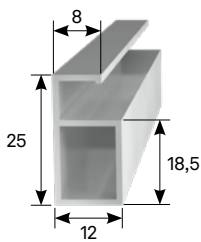

**Insektenschutzprofil •  
Insect Protection Profile**

Bezeichnung Designation	<b>P17</b>
Abmessung Dimension	25 x 12 mm
Länge Length	6000 mm
Legierung Alloy	EN AW-6060 T66 (AlMgSi)

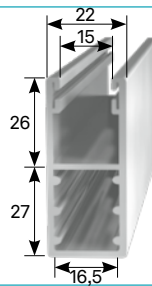

**Rollladenprofil • Roller Blind Profile**

Bezeichnung Designation	<b>B01</b>
Abmessung Dimension	53 x 22 mm
Länge Length	6000 mm
Legierung Alloy	EN AW-6060 T66 (AlMgSi)

# Terrassenbau • Terrace Construction / Building

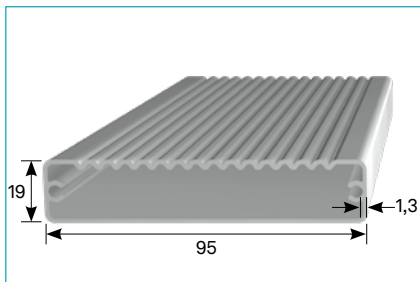

**Terrassendiele • Decking Board**

Bezeichnung Designation	<b>P9519</b>
Abmessung Dimension	95 x 19 x 1,3 mm
Länge Length	6000 mm
Legierung Alloy	EN AW-6060 T66 (AlMgSi)

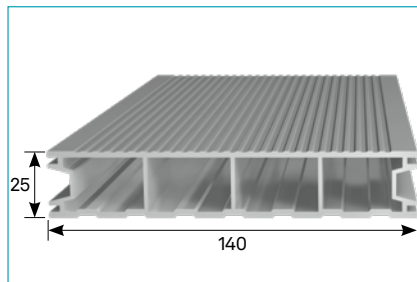

**Terrassendiele • Decking Board**

Bezeichnung Designation	<b>P14025</b>
Abmessung Dimension	140 x 25 mm
Länge Length	6000 mm
Legierung Alloy	EN AW-6060 T66 (AlMgSi)
Info	Passende Flachstange · Matching Flat Bar: 15 x 2 mm (EN AW-6060 T66 (AlMgSi))



**Passende Formrohre für die  
Unterkonstruktion**  
**Matching Rectangular / Square  
tubes for foundation**

**Formrohre  
Rectangular / Square tubes**

A x B x S	Länge Length	kg/m
50 x 25 x 2 mm	6000 mm	0,767
60 x 40 x 1,5 mm	6000 mm	0,788
60 x 40 x 2 mm	6000 mm	1,037
EN AW-6060 T66 (AlMgSi)		



# Tischlerei / Möbelbau • Carpentry / Furniture Construction

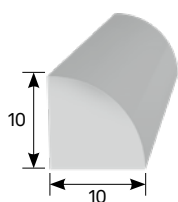

**Viertelstab • Quarter Round**

Bezeichnung Designation	<b>P100</b>
Abmessung Dimension	10 x 10 mm
Länge Length	6000 mm
Legierung Alloy	EN AW-6060 T66 (AlMgSi)
Radius	10 mm

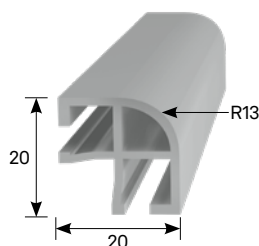

**Kantenprofil • Edge Protection Profile**

Bezeichnung Designation	<b>P126</b>
Abmessung Dimension	20 x 20 mm
Länge Length	6000 mm
Legierung Alloy	EN AW-6060 T66 (AlMgSi)
Info	Eloxiert E6/C0 12 µm · Anodized E6/C0 12 µm

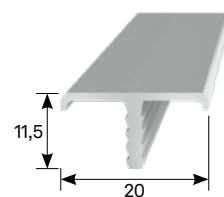

**Kantenschutz • Edge Protection Profile**

Bezeichnung Designation	<b>P200</b>
Abmessung Dimension	20 x 11,5 x 2,5 mm
Länge Length	5000 mm
Legierung Alloy	EN AW-6060 T66 (AlMgSi)
Info	Eloxiert E6/C0 15 µm · Anodized E6/C0 15 µm

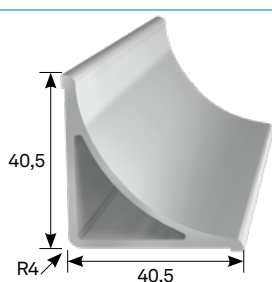

**Wandabschlussprofil •  
Connecting Walls Profile**

Bezeichnung Designation	<b>P36</b>
Abmessung Dimension	40,5 x 40,5 x 2 x 1,6 mm
Länge Length	6000 mm
Legierung Alloy	EN AW-6060 T66 (AlMgSi)

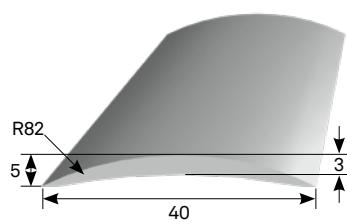

**Hohlhalbrund-Profil •  
Crescentshaped Profile**

Bezeichnung Designation	-
Abmessung Dimension	40 x 5 mm
Länge Length	6500 mm
Legierung Alloy	EN AW-6060 T66 (AlMgSi)

## Volierenbau • Aviary Construction

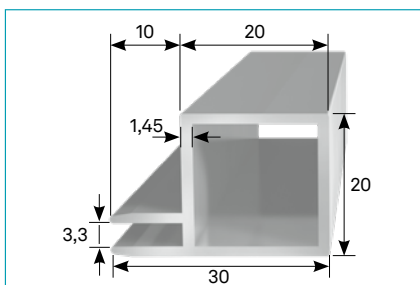

**Volierenprofil • Aviary Profile**

Bezeichnung Designation	<b>P210</b>
Abmessung Dimension	30 x 20 x 1,5 mm
Länge Length	6100 mm
Legierung Alloy	EN AW-6060 T66 (AlMgSi)

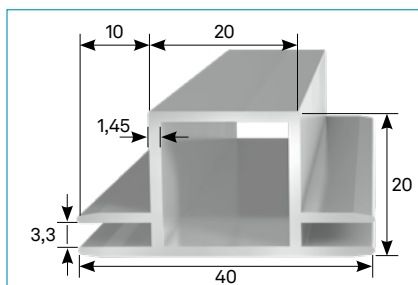

**Volierenprofil • Aviary Profile**

Bezeichnung Designation	<b>P211</b>
Abmessung Dimension	40 x 20 x 1,5 mm
Länge Length	6100 mm
Legierung Alloy	EN AW-6060 T66 (AlMgSi)

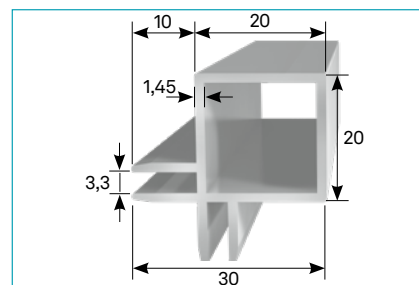

**Volierenprofil • Aviary Profile**

Bezeichnung Designation	<b>P212</b>
Abmessung Dimension	30 x 30 x 1,5 mm
Länge Length	6100 mm
Legierung Alloy	EN AW-6060 T66 (AlMgSi)

Passende Eckverbinder siehe Seite 140 • Matching Connectors see page 140

## Sonstige • Other

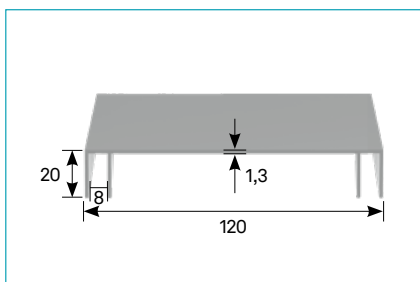

**Leuchtkastenprofil • Light Box Profile**

Bezeichnung Designation	<b>P28</b>
Abmessung Dimension	120 x 20 x 1,3 mm
Länge Length	6000 mm
Legierung Alloy	EN AW-6060 T66 (AlMgSi)

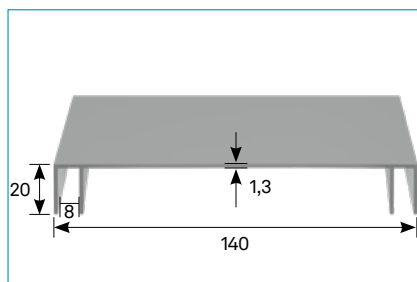

**Leuchtkastenprofil • Light Box Profile**

Bezeichnung Designation	<b>P29</b>
Abmessung Dimension	140 x 20 x 1,3 mm
Länge Length	6000 mm
Legierung Alloy	EN AW-6060 T66 (AlMgSi)

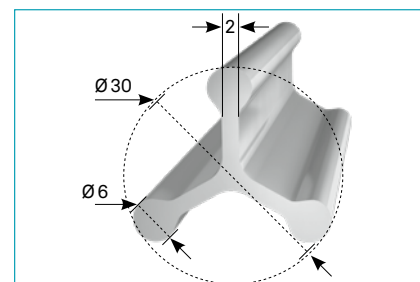

**Wurstlattenprofil / Selchstab • Sausage Rack Bar**

Bezeichnung Designation	<b>P1354</b>
Abmessung Dimension	30 x 6 x 2 mm
Länge Length	6050 mm, 1000 mm
Legierung Alloy	EN AW-6060 T66 (AlMgSi)



**Nottür-Griff • Emergency Door Handle Profile**

Bezeichnung Designation	<b>P4020</b>
Abmessung Dimension	40 x 20 x 3 mm
Länge Length	6000 mm
Legierung Alloy	EN AW-6060 T66 (AlMgSi)
Info	Eloxiert E6/C0 15 µm · Anodized E6/C0 15 µm